



Installing PowerBook G4 Aluminum 17" 1-1.67 GHz PRAM Battery & USB Board

Author: iRobot

Tools used in this guide

- [Phillips #00 Screwdriver](#) (1)
- [Spudger](#) (1)
- [T8 Torx Screwdriver](#) (1)

Parts relevant to this guide

- [G4 Aluminum 17" 1 GHz PRAM Battery & USB Board](#) (1)
- [G4 Aluminum 17" 1.5 GHz PRAM Battery & USB Board](#) (1)
- [G4 Aluminum 17" 1.33 GHz PRAM Battery & USB Board](#) (1)
- [G4 Aluminum 17" 1.67 GHz \(LR\) PRAM Battery & USB Board](#) (1)

Is your clock resetting itself or USB on the right side not working? Replace it!

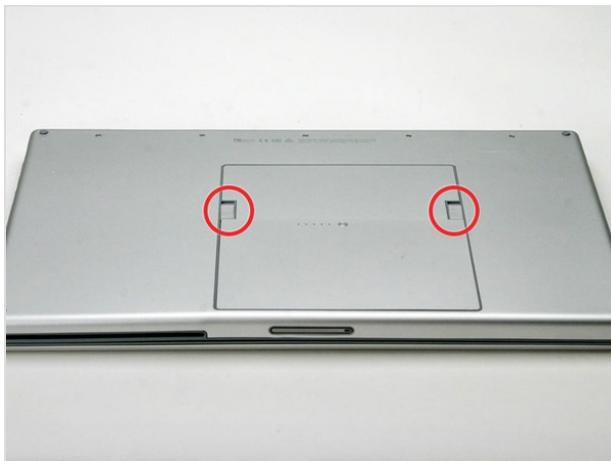

Step 1 — Battery

- Orient the computer so that the side with the line of screws on it is away from you.
- Use your thumbs to push both battery release tabs away so that the edge of the battery lifts up.
- Lift the battery out of the computer.

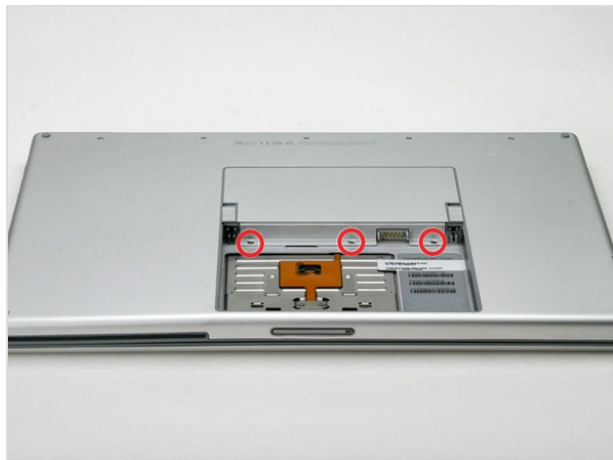

Step 2 — Upper Case

- Remove the three identical Phillips screws from the memory door.



Step 3

- Lift the memory door up enough so that you can get a grip on it, and slide it toward you, pulling it away from the casing.



Step 4

- Release the tabs on each side of the RAM chip at the same time. These tabs lock the chip in place and releasing them will cause the chip to "pop" up.
- Pull the chip directly out from its connectors. If there is a second RAM chip installed, pop it out in the same manner.

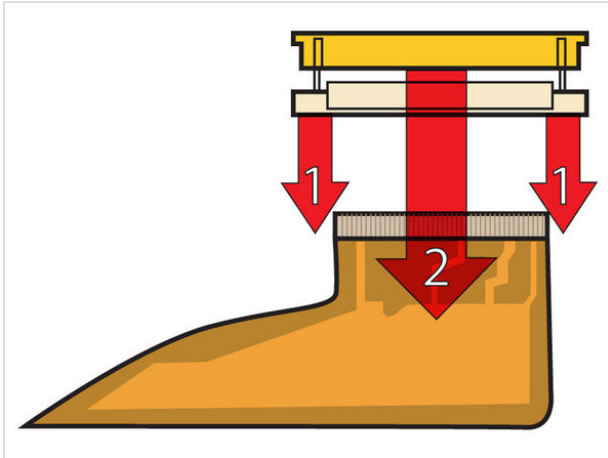



Step 5

- This is a diagram of the trackpad ribbon clamp connector you will disconnect in the next step. 
- 1) With your fingernails, grasp the locking bar on either side slide it a small amount (about 1/16" or 2 mm) towards the battery.
- 2) After disengaging the locking bar, slide the cable out of the connector.



Step 6

- For this step, you only need to move the connector about 2 mm. Pulling too hard or too far will damage the connector. 
- Loosen the trackpad connector by pulling the locking bar toward the battery housing, using the tips of your fingers.
- Slide the trackpad cable out of the loosened connector.
- When reattaching the trackpad ribbon cable, make sure that the orange cable is slid into the connector above the locking bar. 
- Note: When reassembling the case, the trackpad cable can get stuck below the slot to the motherboard. It's possible to nudge it out slowly by gently prodding it on either side with a small screwdriver. You don't need to use much force to do this. Eventually it will just pop back out and you can reconnect as per the instructions above. Also, note that the locking bar comes loose so if you see a little piece of plastic lying around when reassembling, that's what it is. :)

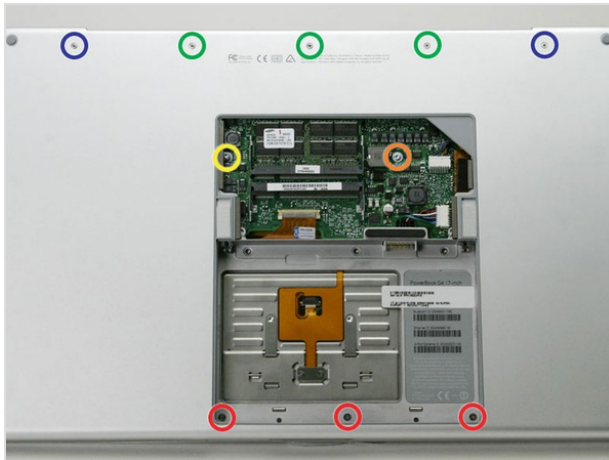

Step 7

- Remove the following 10 screws from the bottom case:
 - Three 1.7 mm Phillips from the front edge of the battery compartment.
 - One 3.9 mm T8 Torx to the right of the memory card.
 - One 6.9 mm T8 Torx at the left edge of the memory compartment.
 - Three 12.4 mm fully threaded Phillips from the center of the row of screws along the back edge of the case.
 - Two 15.1 mm 2.5 mm threaded Phillips, one from either end of the row of screws along the back edge of the case.



Step 8

- Turn the computer over and rotate it so that the DVI port faces you.
- Remove the four identical Phillips screws spread along this edge of the case.



Step 9

- Turn the computer 180 degrees so that the power receptacle faces you, and remove the four Phillips screws (identical to those in the last step).



Step 10

- Open the computer and turn it so that the screen faces you.
- Pull the upper case off, lifting from the back, and working around the edges.



Step 11

- Use a spudger to loosen the casing if it sticks.
- Once the casing is entirely free, lift it off of the computer.

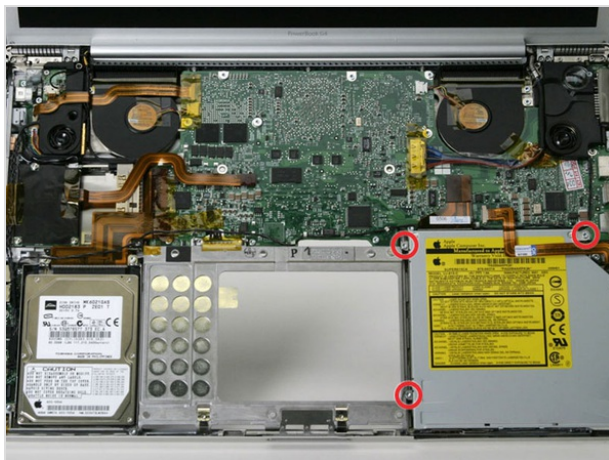

Step 12 — SuperDrive

- Remove the four T8 Torx screws from the four corners of the SuperDrive.
- The shorter screw goes in the front, right corner.



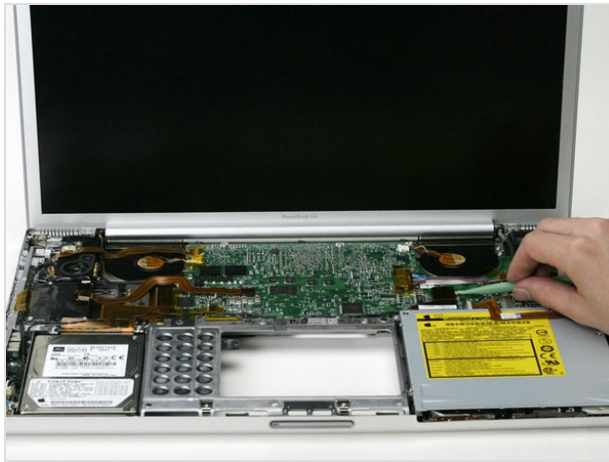

Step 13

- The optical drive ribbon cable is very fragile. Be sure to gently lift up the cable on the sides. Do not lift up on the cable from the end closest to the display. 
- Carefully disconnect the orange optical drive ribbon from the logic board.



Step 14

- Lift the optical drive at the right, front corner, and slide it out of the computer (be careful not to catch the PRAM battery cable).
- If you have a CD or any other object jammed in your optical drive, we have an [optical drive repair guide](#). 



Step 15 — PRAM Battery & USB Board

- Use the method described in the step for disconnecting the keyboard ribbon to loosen the connectors at either end of the PRAM battery ribbon.
- Remove the ribbon from the connectors.



Step 16

- Remove the three T8 Torx screws from the PRAM battery board.

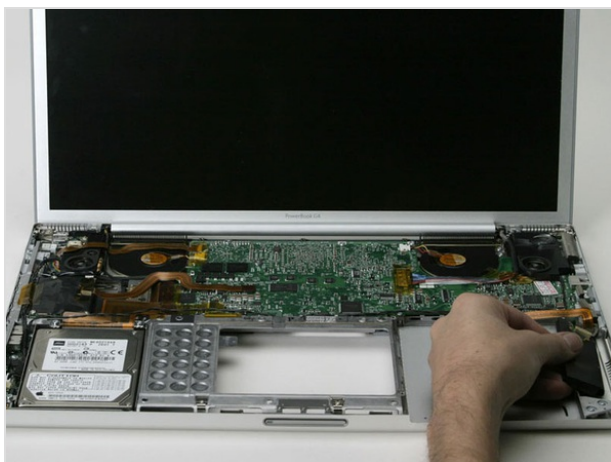

Step 17

- Lift the board out of the computer.

To reassemble your device, follow these instructions in reverse order.

This document was last generated on Apr 8, 2012.