



# Installing iBook G3 14" Logic Board

Author: iRobot

## Tools used in this guide

- [Anti-Static Wrist Strap](#) (1)
- [Coin](#) (1)
- [Paper Clip](#) (1)
- [Phillips #00 Screwdriver](#) (1)
- [Small Flathead Screwdriver](#) (1)
- [Spudger](#) (1)
- [T8 Torx Screwdriver](#) (1)

## Parts relevant to this guide

- [iBook G3 14" 800 MHz Logic Board](#) (1)

The motherboard includes all ports except the DC-In board.



## Step 1 — Battery

- Use a coin to rotate the battery locking screw 90 degrees clockwise.
- Lift the battery out of the computer.



## Step 2 — Keyboard

- Pull the keyboard release tabs (highlighted in red) toward you and lift up on the keyboard until it pops free.
- If the keyboard does not come free, use a small flathead screwdriver to turn the keyboard locking screw 180 degrees in either direction and try again.
- Flip the keyboard over, away from the screen, and rest it face-down on the trackpad area.



## Step 3

- If your computer does not have an AirPort card installed, skip to the RAM shield removal step. 
- Push the wire clasp toward the AirPort card and pull it up to free it from the RAM shield.



## Step 4

- Grasp the clear plastic tab on the AirPort card and pull toward the right.

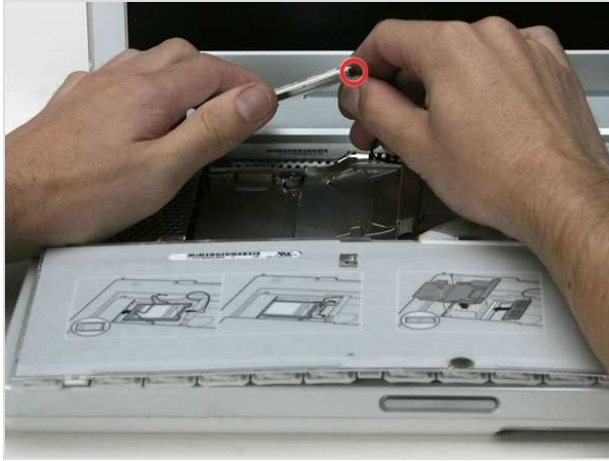

## Step 5

- Hold the AirPort card in one hand and use your other hand to remove the antenna cable.

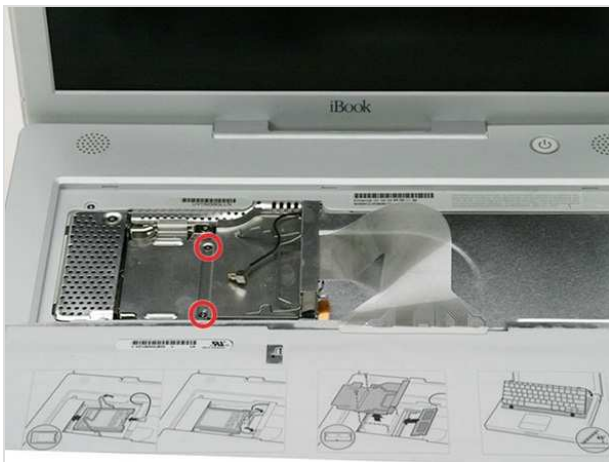

## Step 6

- Remove the two Phillips screws that secure the RAM shield.

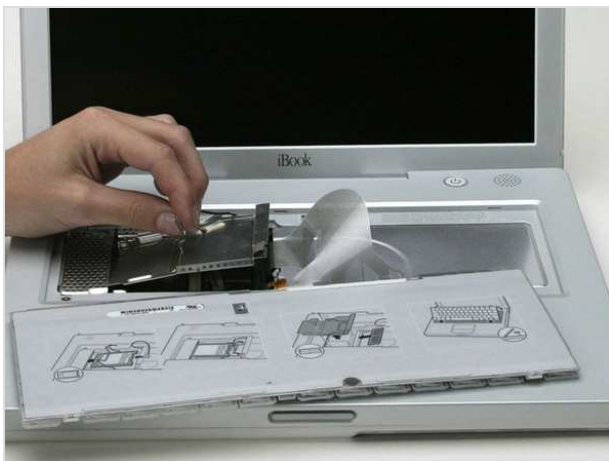

## Step 7

- Grasp the metal bracket on top of the RAM shield and pull upward to remove the shield.

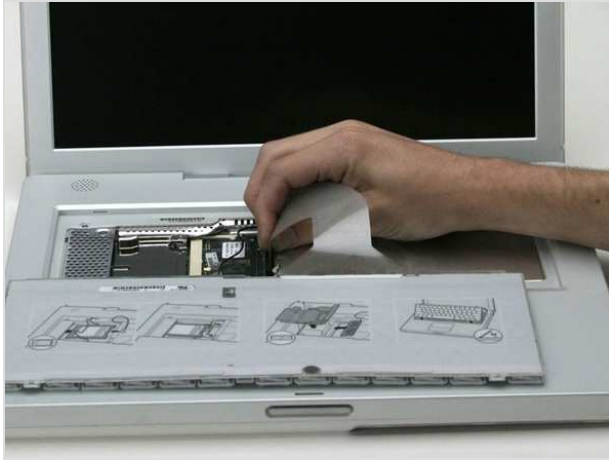

## Step 8

- Pull the keyboard cable up from the logic board, holding the cable as close to the connector as possible.

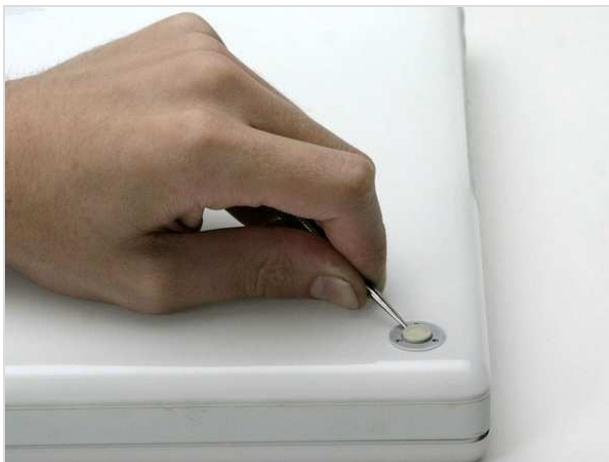

## Step 9 — Lower Case

- Use a pin to remove the three rubber feet from the lower case.



## Step 10

- Remove the three newly-revealed Phillips screws.



## Step 11

- Use a spudger or small flathead screwdriver to pry up the three metal rings that housed the rubber bumpers.



## Step 12

- Remove the three hex screws using a T8 Torx screwdriver.
- The screw in the center is shorter than the other two.



## Step 13

- Remove the two Phillips screws on either side of the battery contacts.



## Step 14

- Breathe deeply. Trying times are ahead, but we promise the lower case does come off. 
- Push the thin rims of the lower case surrounding the battery compartment in, bending them past the tabs, and then lift up to free that corner of the lower case.



## Step 15

- There is a slot on the wall of the battery compartment that locks the lower case in place. 
- Use a small flathead screwdriver to pry out the slot's lower rim and pull up on the lower case to free the slot from the tabs holding it.



## Step 16

- Run a spudger along the seam between the lower case and upper case on the front of the computer to free the tabs locking the lower case.
- Pull up on the lower case and continue to use the spudger as necessary until you hear three distinct clicks.



## Step 17

- Continue to run the spudger around the front, right corner.
- There are two tabs on the port side of the computer, one near the front corner and one near the sound out port.



## Step 18

- Once the front and sides of the lower case are free, turn the computer so that the back is facing you.
- Pull the lower case up and toward you until the back tabs pop free.
- It may be helpful to jiggle the case up and down.



## Step 19

- Remove the small greasy springs with white plastic caps from either side of the battery contacts.



## Step 20 — Upper Case

- All of the screws in the following step have small heads - the screws with larger heads hold the bottom shield on. 
- Remove the following 9 screws on the bottom of the computer:
  - Three 3 mm Phillips around the battery compartment.
  - Three 5 mm Phillips on the left and bottom edges.
  - Three 14.5 mm Phillips on the top and right edges (you may have to peel back the foil tape to reveal the screw near the security lock slot).



## Step 21

- Turn over the computer and open it.
- Pry up the magnet covering a Phillips screw near the middle of the computer.
- You may need to peel back the serial number sticker to access the magnet. 



## Step 22

- Remove the following 3 screws on the edges of the keyboard area:
  - Two 6 mm Phillips underneath the keyboard area.
  - One 9 mm Phillips above the keyboard area.
- On some models, there may also be a screw under the magnet you just removed. If so, remove the screw at this point. 

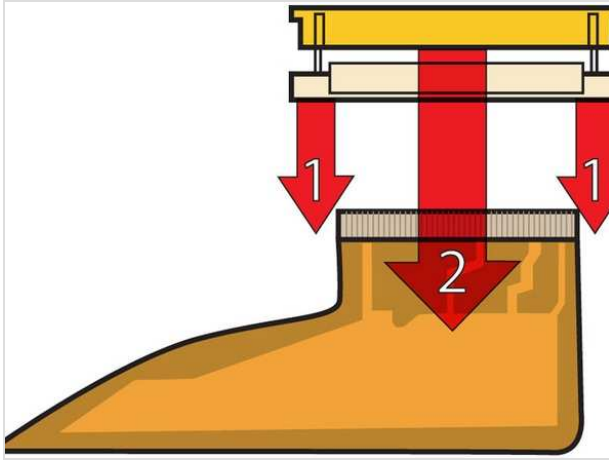

## Step 23

- This is a diagram of the ribbon clamp connectors you will disconnect in the next step. 
- With your fingernails, grasp the locking bar on either side and pull up a small amount (about 1/16" or 2 mm).
- After disengaging the locking bar, slide the cable out of the connector.



## Step 24

- Loosen the trackpad connector by pulling the top piece up slightly, freeing the trackpad ribbon.
- Slide the orange trackpad ribbon out of the connector.



## Step 25

- Use a straightened paperclip to open the optical drive tray, and pull it out about halfway.





## Step 26

- Don't lift the upper case off the computer yet as there are still two cables left to disconnect. 
- Lift the upper case from the left side and use your other hand to pull out the right side in order to clear the power receptacle.



## Step 27

- The connectors at the ends of the cables are attached very firmly to the sockets on the logic board. Pulling directly on the cable will either separate the cable from its connector or the socket from the logic board. 
- Lift the upper case enough to disconnect the blue and white power cable from the logic board.
- Using your fingernails or a dental pick, carefully pry the connector from its socket.
- Make sure you are pulling only on the connector and not on the socket. 



## Step 28

- Lift the upper case off completely and disconnect the red and black speaker cable from the logic board.
- Make sure you are pulling only on the connector and not on the socket. 

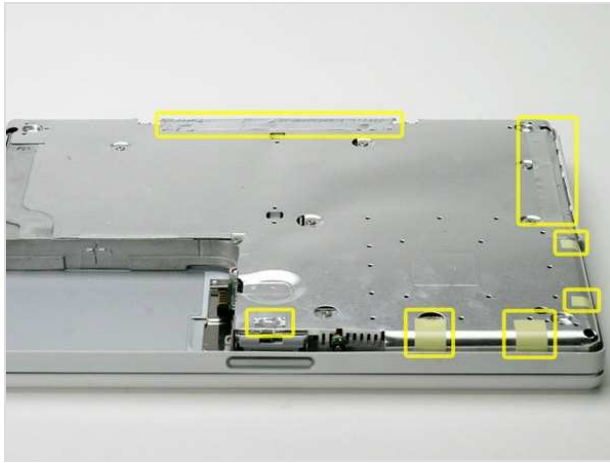

## Step 29 — Bottom Shield

- Peel back the yellow tape and foil shielding.

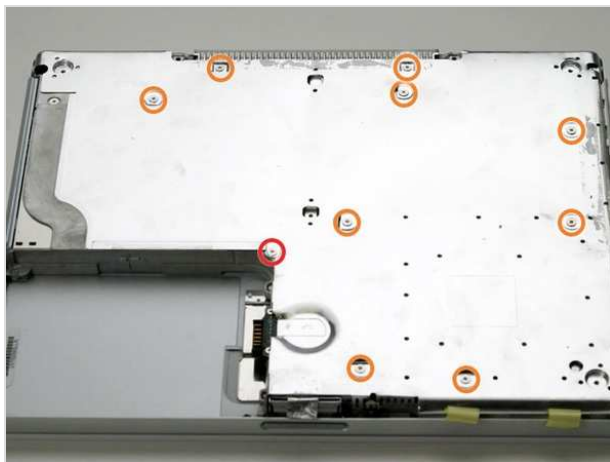

## Step 30

- Remove the following 10 screws:
  - One 5 mm Phillips at the upper, right corner of the battery compartment.
  - Nine 6 mm Phillips scattered around the shield.
- Lift the bottom shield off.



## Step 31 — Fan

- Remove the single Phillips screw on the left side of the fan.
- Lift the fan out of its housing and disconnect it from the logic board.

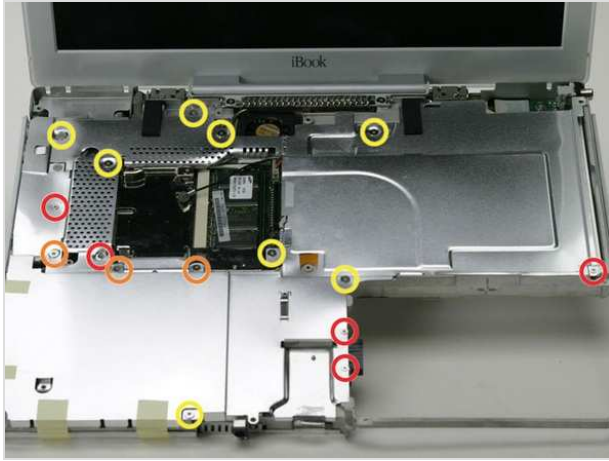

## Step 32 — Top Shield

- Remove the following 16 screws:
  - Five 3 mm Phillips (these have smaller heads than the others).
  - Three 5 mm Phillips.
  - Eight 6 mm Phillips.

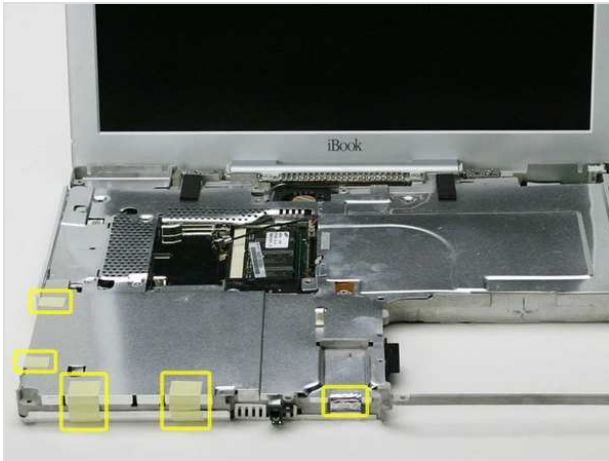

## Step 33

- If you have already removed the yellow tape, skip this step. 
- Peel back three strips of yellow tape in the bottom, left corner.
- Peel back one strip of foil tape near the audio-out port, one near where the trackpad connects to the logic board, and one near where the screen latch used to be.



## Step 34

- Lift the top shield up from the right side, minding the upper left corner, which may catch on the metal framework.



## Step 35 — Modem

- Remove the single strip of tape running across the modem.
- Remove the single Phillips screw securing the display data cable to the metal framework.



## Step 36

- Move the display data cable in order to access and remove a single Phillips screw from the front left corner of the modem.
- Remove the single Phillips screw remaining at the upper, right corner of the modem.



## Step 37

- Lift the modem from the logic board on the right side, being careful not to strain the display data cable.
- Disconnect the modem cable from the upper, left corner of the modem.



## Step 38

- Slide the modem out of the computer, being careful to avoid catching the black plastic shielding on the surrounding cables.



## Step 39 — Hard Drive

- Remove the single Phillips screw to the right of the hard drive connector.



## Step 40

- At the front edge of the hard drive, lift up on the transparent orange tape to disconnect the ribbon cable from the main board.



## Step 41

- Peel back the black tape to free the microphone cable from the hard drive.

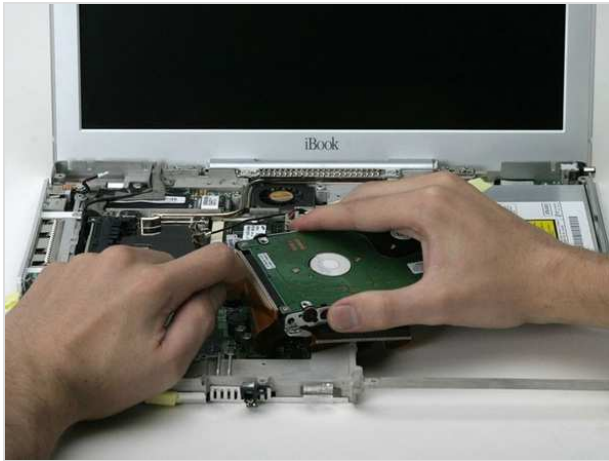

## Step 42

- Lift the hard drive out of the computer and turn the hard drive over. Use the transparent orange loop to disconnect the hard drive ribbon cable from the hard drive.
- This is a bit tricky. Try rocking the cable gently from side to side while applying even pressure. If you bend the pins, do your best to straighten them, using the hard drive cable as a guide.



## Step 43 — IO Bezel

- Remove the single Phillips from the white plastic finger of the IO Bezel.



## Step 44

- Slide the IO Bezel away from the computer and off.

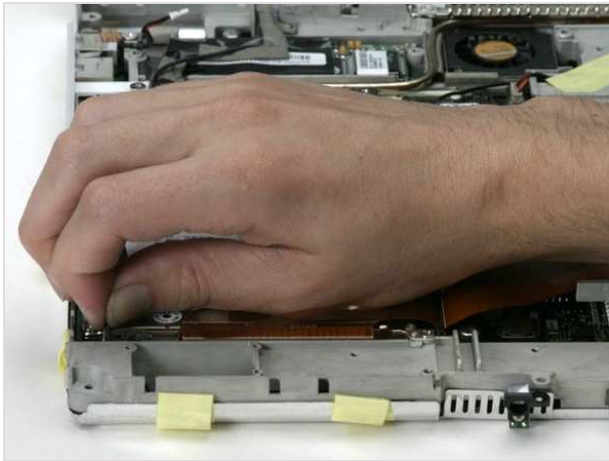

## Step 45 — Display

- If you have already removed the hard drive, ignore its presence in the following steps. The hard drive does not affect the display removal. 
- Disconnect the microphone cable from the front, left corner of the logic board.
- Peel back the black tape and free the microphone cable from the hard drive.



## Step 46

- Use the black plastic handle to disconnect the display data cable from the logic board.



## Step 47

- If you have already removed the modem, you will only need to remove one of these screws. 
- Remove the two Phillips screws securing the display data cable to the metal framework.



## Step 48

- Deroute the display data and microphone cables, removing tape as necessary.



## Step 49

- Peel back the yellow tape securing the inverter cable to the metal framework.

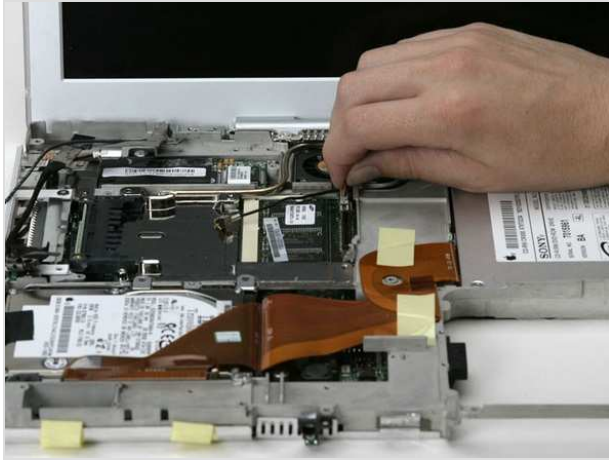

## Step 50

- Disconnect the inverter cable from the logic board.
- Carefully deroute the inverter cable from beneath the optical drive.



## Step 51

- Deroute the AirPort antenna cable from beneath the optical drive.



## Step 52

- Support the display with your free hand removing the following screws. 
- Remove the single Phillips screw on the outer edge of either hinge (two screws total).
- Tilt the display back to get over two small nubbins, and then slide it directly from the case and away.



## Step 53 — Logic Board

- Remove the following 9 screws:
  - Two 3 mm Phillips from the edge of the logic board, near the battery
  - Two 4 mm large head Phillips on the port side, from either corner.
  - One 6 mm Phillips near the sleep light.
  - Two 7.5 mm Phillips securing the battery connector to the metal framework.
  - Two 5 mm Phillips from the logic board. These screws may not be present on some models.
- There will be two screws remaining that secure the airport card cage to the logic board (can't get them all).



## Step 54

- Disconnect the sleep light from the logic board.

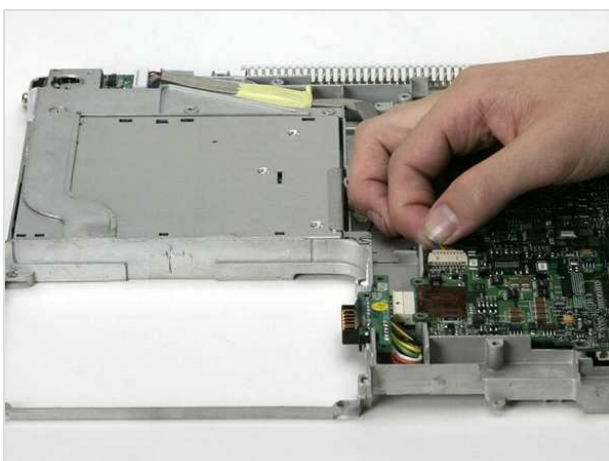

## Step 55

- Disconnect the DC cable from the logic board.



## Step 56

- Remove the three Phillips screws securing the heat sink to the metal framework.
- Remove the rear plastic grill.

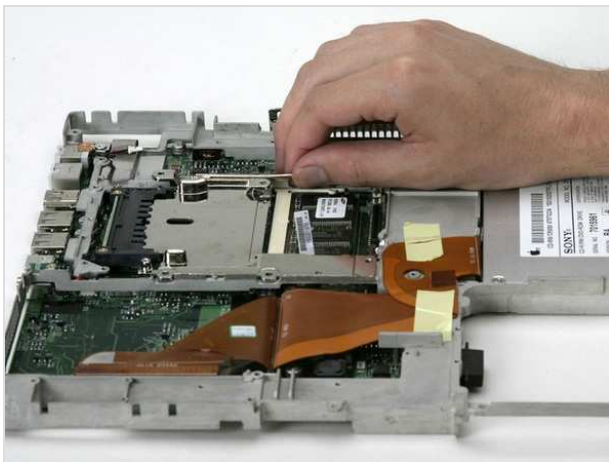

## Step 57

- Lift the heat sink out of the computer.
- If you need to mount the heat sink back into the laptop, we have a [thermal paste guide](#) that makes replacing the thermal compound easy.



## Step 58

- Remove the single Phillips screw that secures the logic board to the metal framework and remove the metal shielding.
- Peel back the foil tape securing the logic board to the RJ-11 jack.



## Step 59

- Disconnect the reset button from the logic board. (this part is not present on later models)



## Step 60

- Lift the metal framework up and off the logic board.
- Now would be a good time to remove the battery connector and RAM from your (now) old logic board if you're planning to keep them.







To reassemble your device, follow these instructions in reverse order.



This document was last generated on Feb 23, 2012.





↓



   
Keyboard  
2 Phillips Screws



   
Lower Case (under feet)  
3 Phillips



   
Lower Case  
2 T8 Torx

   
Lower Case  
1 T8 Torx

↓

   
Lower Case (battery compartment)  
2 Phillips

   
Upper Case bottom (red)  
3 Phillips

   
Upper Case bottom (orange)  
3 Phillips

↙ ↘







To organize your screws, simply place each screw in the appropriate box as you remove them from your laptop.



If you are not planning on immediately reassembling your laptop, you may want to tape the screws to this paper.



Due to model variations, the screws you remove may differ slightly from this guide.

↓



   
Upper Case bottom (yellow)  
3 Phillips



   
Upper Case top (red)  
2 Phillips



   
Upper Case top (orange)  
1 Phillips

   
Bottom Shield (red)  
1 Phillips

↓

   
Bottom Shield (orange)  
9 Phillips

   
Fan  
1 Phillips

   
Top Shield (red)  
5 Phillips

↓



↓



Top Shield (orange)  
3 Phillips



Top Shield (yellow)  
8 Phillips

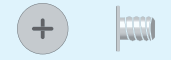

Modem  
2 Phillips

↓



Hard Drive  
1 Phillips

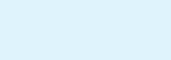

HD Replacement  
4 T8 Torx



Optical Drive  
2 Phillips

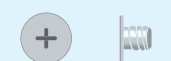

Optical Drive (cable)  
2 Phillips

↙ ↘



To organize your screws, simply place each screw in the appropriate box as you remove them from your laptop.

If you are not planning on immediately reassembling your laptop, you may want to tape the screws to this paper.

Due to model variations, the screws you remove may differ slightly from this guide.



IO Bezel  
1 Phillips

↓



DC-In Board  
1 Phillips



Display (data cable)  
2 Phillips

↓



Display  
2 Phillips

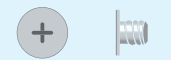

Logic Board (red)  
2 Phillips



Logic Board (orange)  
2 Phillips



Logic Board (yellow)  
1 Phillips



