



Installing iBook G3 14" Optical Drive

Author: iRobot

Tools used in this guide

- [Coin](#) (1)
- [Paper Clip](#) (1)
- [Phillips #00 Screwdriver](#) (1)
- [Small Flathead Screwdriver](#) (1)
- [Spudger](#) (1)
- [T8 Torx Screwdriver](#) (1)

Parts relevant to this guide

- [iBook G3 14" Combo Drive](#) (1)

Upgrade or replace the DVD or Combo drive.



Step 1 — Battery

- Use a coin to rotate the battery locking screw 90 degrees clockwise.
- Lift the battery out of the computer.



Step 2 — Keyboard

- Pull the keyboard release tabs (highlighted in red) toward you and lift up on the keyboard until it pops free.
- If the keyboard does not come free, use a small flathead screwdriver to turn the keyboard locking screw 180 degrees in either direction and try again.
- Flip the keyboard over, away from the screen, and rest it face-down on the trackpad area.



Step 3

- If your computer does not have an AirPort card installed, skip to the RAM shield removal step.
- Push the wire clasp toward the AirPort card and pull it up to free it from the RAM shield.

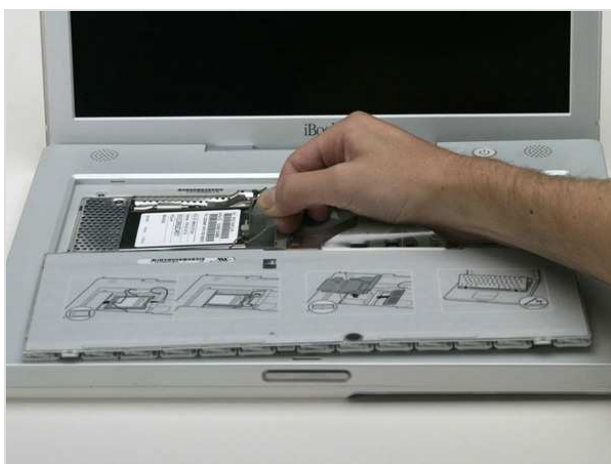

Step 4

- Grasp the clear plastic tab on the AirPort card and pull toward the right.

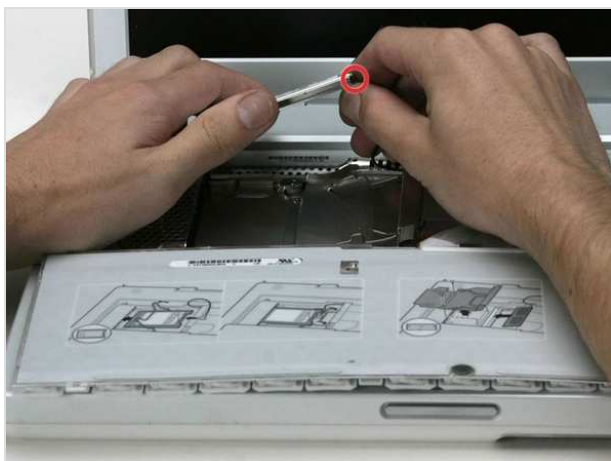

Step 5

- Hold the AirPort card in one hand and use your other hand to remove the antenna cable.

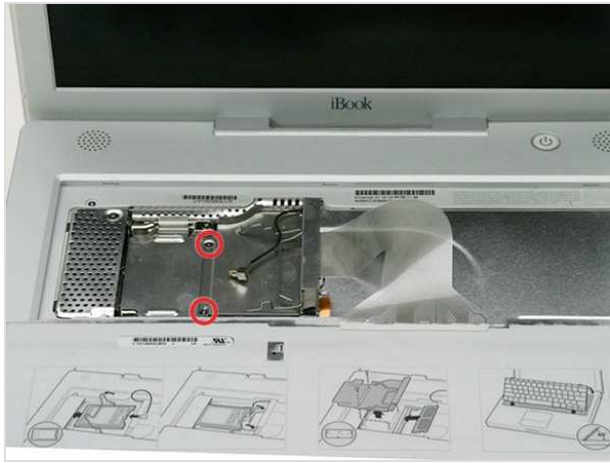

Step 6

- Remove the two Phillips screws that secure the RAM shield.

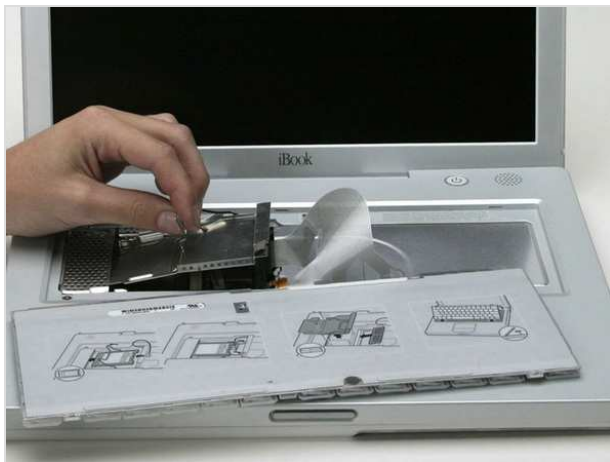

Step 7

- Grasp the metal bracket on top of the RAM shield and pull upward to remove the shield.

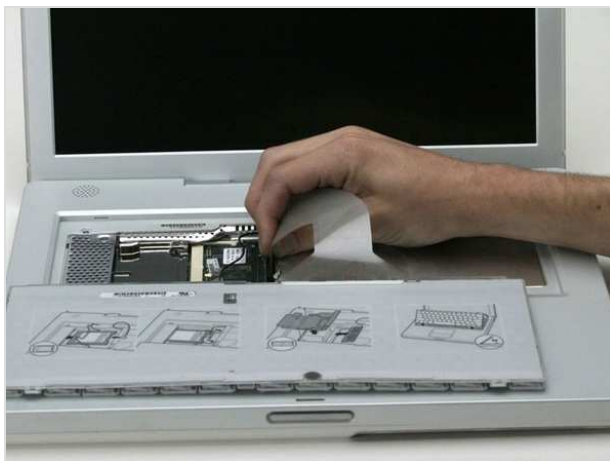

Step 8

- Pull the keyboard cable up from the logic board, holding the cable as close to the connector as possible.

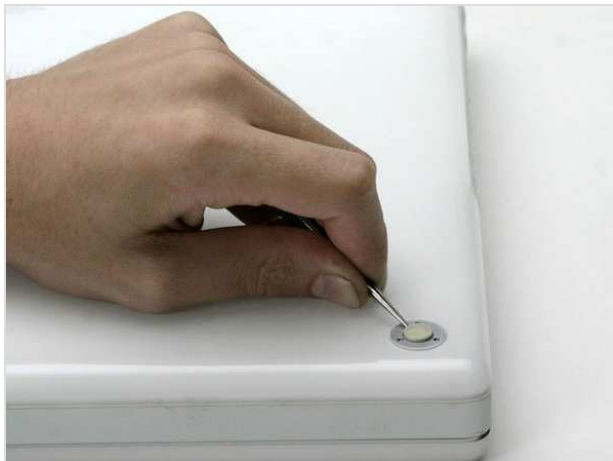

Step 9 — Lower Case

- Use a pin to remove the three rubber feet from the lower case.



Step 10

- Remove the three newly-revealed Phillips screws.



Step 11

- Use a spudger or small flathead screwdriver to pry up the three metal rings that housed the rubber bumpers.



Step 12

- Remove the three hex screws using a T8 Torx screwdriver.
- The screw in the center is shorter than the other two.



Step 13

- Remove the two Phillips screws on either side of the battery contacts.



Step 14

- Breathe deeply. Trying times are ahead, but we promise the lower case does come off.
- Push the thin rims of the lower case surrounding the battery compartment in, bending them past the tabs, and then lift up to free that corner of the lower case.





Step 15

- There is a slot on the wall of the battery compartment that locks the lower case in place. 
- Use a small flathead screwdriver to pry out the slot's lower rim and pull up on the lower case to free the slot from the tabs holding it.



Step 16

- Run a spudger along the seam between the lower case and upper case on the front of the computer to free the tabs locking the lower case.
- Pull up on the lower case and continue to use the spudger as necessary until you hear three distinct clicks.



Step 17

- Continue to run the spudger around the front, right corner.
- There are two tabs on the port side of the computer, one near the front corner and one near the sound out port. 



Step 18

- Once the front and sides of the lower case are free, turn the computer so that the back is facing you.
- Pull the lower case up and toward you until the back tabs pop free.
- It may be helpful to jiggle the case up and down.



Step 19

- Remove the small greasy springs with white plastic caps from either side of the battery contacts.



Step 20 — Upper Case

- All of the screws in the following step have small heads - the screws with larger heads hold the bottom shield on.
- Remove the following 9 screws on the bottom of the computer:
 - Three 3 mm Phillips around the battery compartment.
 - Three 5 mm Phillips on the left and bottom edges.
 - Three 14.5 mm Phillips on the top and right edges (you may have to peel back the foil tape to reveal the screw near the security lock slot).





Step 21

- Turn over the computer and open it.
- Pry up the magnet covering a Phillips screw near the middle of the computer.
- You may need to peel back the serial number sticker to access the magnet.



Step 22

- Remove the following 3 screws on the edges of the keyboard area:
 - Two 6 mm Phillips underneath the keyboard area.
 - One 9 mm Phillips above the keyboard area.
- On some models, there may also be a screw under the magnet you just removed. If so, remove the screw at this point.

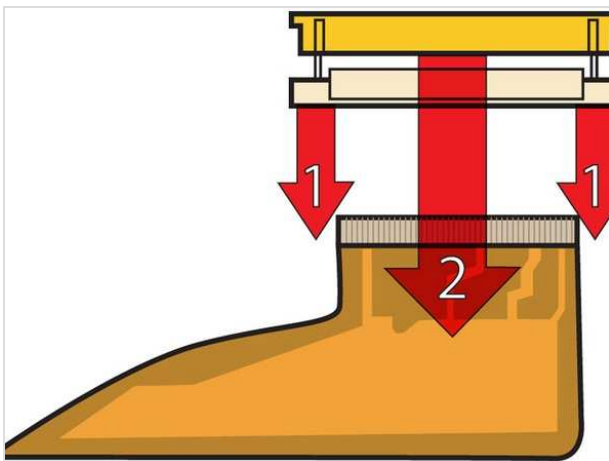

Step 23

- This is a diagram of the ribbon clamp connectors you will disconnect in the next step.
- With your fingernails, grasp the locking bar on either side and pull up a small amount (about 1/16" or 2 mm).
- After disengaging the locking bar, slide the cable out of the connector.





Step 24

- Loosen the trackpad connector by pulling the top piece up slightly, freeing the trackpad ribbon.
- Slide the orange trackpad ribbon out of the connector.



Step 25

- Use a straightened paperclip to open the optical drive tray, and pull it out about halfway.





Step 26

- Don't lift the upper case off the computer yet as there are still two cables left to disconnect.
- Lift the upper case from the left side and use your other hand to pull out the right side in order to clear the power receptacle.





Step 27

- The connectors at the ends of the cables are attached very firmly to the sockets on the logic board. Pulling directly on the cable will either separate the cable from its connector or the socket from the logic board. 
- Lift the upper case enough to disconnect the blue and white power cable from the logic board.
- Using your fingernails or a dental pick, carefully pry the connector from its socket.
- Make sure you are pulling only on the connector and not on the socket. 



Step 28

- Lift the upper case off completely and disconnect the red and black speaker cable from the logic board.
- Make sure you are pulling only on the connector and not on the socket. 

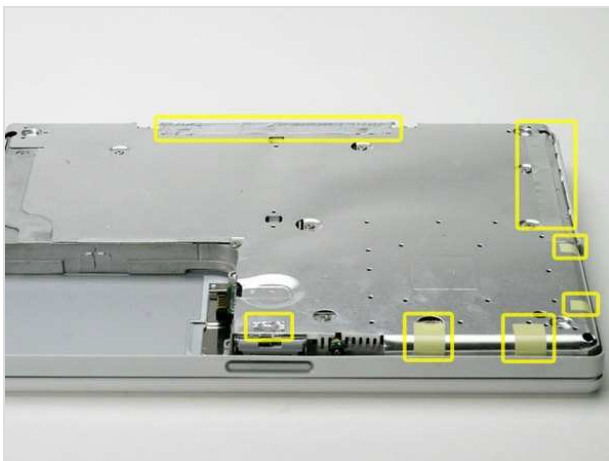

Step 29 — Bottom Shield

- Peel back the yellow tape and foil shielding.

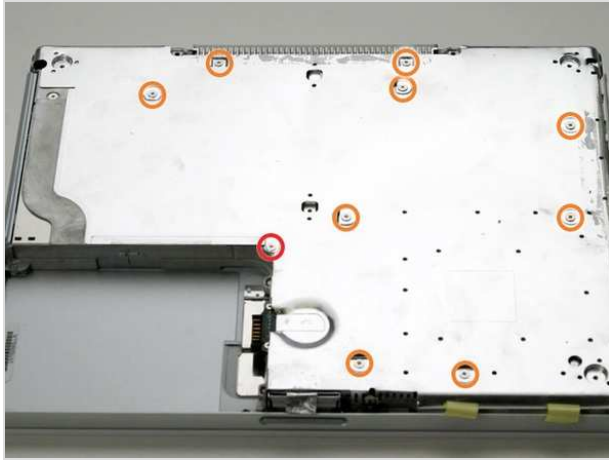

Step 30

- Remove the following 10 screws:
 - One 5 mm Phillips at the upper, right corner of the battery compartment.
 - Nine 6 mm Phillips scattered around the shield.
- Lift the bottom shield off.

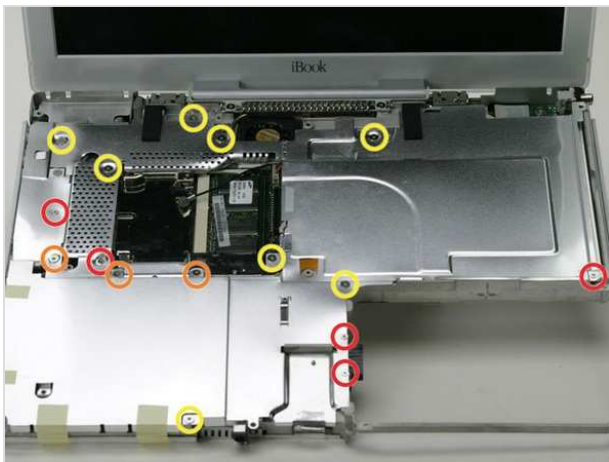

Step 31 — Top Shield

- Remove the following 16 screws:
 - Five 3 mm Phillips (these have smaller heads than the others).
 - Three 5 mm Phillips.
 - Eight 6 mm Phillips.

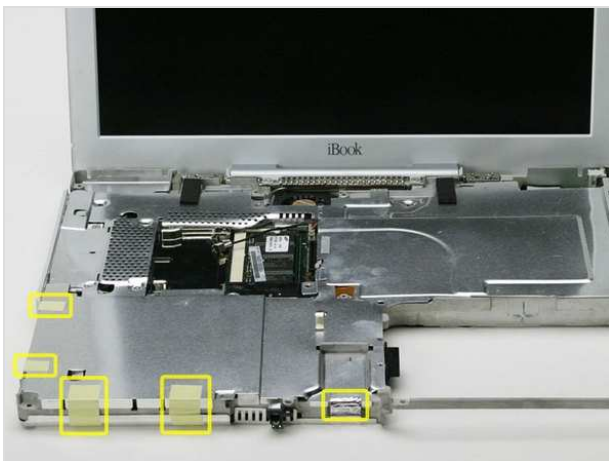

Step 32

- If you have already removed the yellow tape, skip this step.
- Peel back three strips of yellow tape in the bottom, left corner.
- Peel back one strip of foil tape near the audio-out port, one near where the trackpad connects to the logic board, and one near where the screen latch used to be.





Step 33

- Lift the top shield up from the right side, minding the upper left corner, which may catch on the metal framework.



Step 34 — Optical Drive

- On the bottom of the computer, remove the two Phillips screws securing the optical drive to the metal framework.
- Open the optical drive using a straightened paperclip (if it's not already opened).



Step 35

- The next step will probably be incredibly difficult and frustrating - get comfortable. 
- Using a small flathead screwdriver, pry up the small tab securing the faceplate to the optical drive.



Step 36

- Pry up the white plastic tab on the other end of the drive. Pull the optical drive faceplate off, rotating it up and down slightly to get over the remaining two tabs.



Step 37

- Turn the computer over and open the display.
- Remove the three pieces of yellow tape securing the optical drive and inverter cable to the metal framework.



Step 38

- Pull out on the right edge of the metal casing and lift the edge of the optical drive up.



Step 39

- Free the inverter cable and Airport antenna cable from the corner of the optical drive and lift the drive up so that it stands vertical.

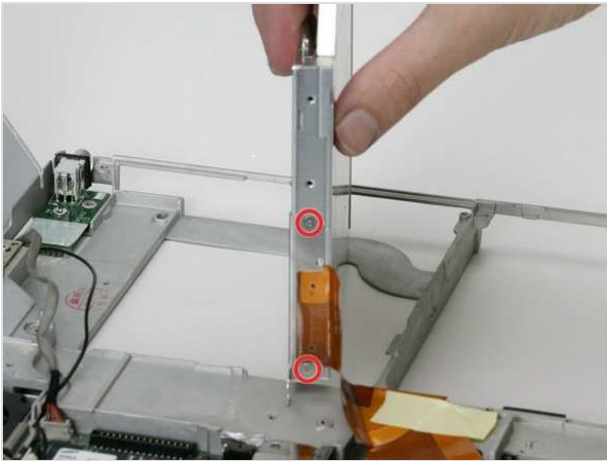

Step 40

- Remove the two Phillips screws and faceplate securing the large orange ribbon cable to the optical drive.



Step 41

- Disconnect the orange ribbon cable from the optical drive.
- If you have a CD or any other object jammed in your optical drive, we have an [optical drive repair guide](#).







To reassemble your device, follow these instructions in reverse order.



This document was last generated on Feb 23, 2012.





↓



 
Keyboard
2 Phillips Screws



 
Lower Case (under feet)
3 Phillips



 
Lower Case
2 T8 Torx

 
Lower Case
1 T8 Torx

↓

 
Lower Case (battery compartment)
2 Phillips

 
Upper Case bottom (red)
3 Phillips

 
Upper Case bottom (orange)
3 Phillips



↙ ↘





To organize your screws, simply place each screw in the appropriate box as you remove them from your laptop.



If you are not planning on immediately reassembling your laptop, you may want to tape the screws to this paper.



Due to model variations, the screws you remove may differ slightly from this guide.

 
Upper Case bottom (yellow)
3 Phillips



↓



 
Upper Case top (red)
2 Phillips



 
Upper Case top (orange)
1 Phillips

 
Bottom Shield (red)
1 Phillips



↓

 
Bottom Shield (orange)
9 Phillips

 
Fan
1 Phillips

 
Top Shield (red)
5 Phillips

↓





Top Shield (orange)
3 Phillips

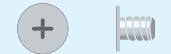

Top Shield (yellow)
8 Phillips



Modem
2 Phillips



Hard Drive
1 Phillips

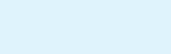

HD Replacement
4 T8 Torx



Optical Drive
2 Phillips



Optical Drive (cable)
2 Phillips





To organize your screws, simply place each screw in the appropriate box as you remove them from your laptop.

If you are not planning on immediately reassembling your laptop, you may want to tape the screws to this paper.

Due to model variations, the screws you remove may differ slightly from this guide.





IO Bezel
1 Phillips

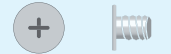

DC-In Board
1 Phillips



Display (data cable)
2 Phillips



Display
2 Phillips

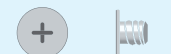

Logic Board (red)
2 Phillips



Logic Board (orange)
2 Phillips



Logic Board (yellow)
1 Phillips



