



Installing iBook G3 12" Optical Drive

Author: iRobot

Tools used in this guide

- [Coin](#) (1)
- [Paper Clip](#) (1)
- [Phillips #00 Screwdriver](#) (1)
- [Push Pin](#) (1)
- [Small Flathead Screwdriver](#) (1)
- [Spudger](#) (1)
- [T8 Torx Screwdriver](#) (1)

Parts relevant to this guide

- [iBook G3 12" Combo Drive](#) (1)

Upgrade or replace the CD, DVD, or Combo drive.



Step 1 — Battery

- Use a coin to rotate the battery locking screw 90 degrees clockwise.
- Lift the battery out of the computer.



Step 2 — Keyboard

- Pull the keyboard release tabs toward you and lift up on the keyboard until it pops free.
- If the keyboard does not come free, use a small flathead screwdriver to turn the keyboard locking screw 180 degrees in either direction and try again.
- Flip the keyboard over, away from the screen, and rest it face-down on the trackpad area.

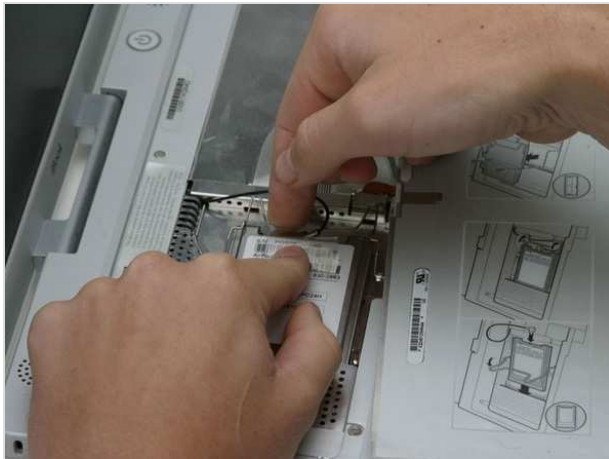

Step 3

- If the computer does not have an Airport card installed, skip the next two steps. 
- Push the wire clasp toward the Airport card and pull it up to free it from the RAM shield.



Step 4

- Grasp the clear plastic tab on the Airport card and pull toward the right.



Step 5

- Hold the Airport card in one hand and use your other hand to remove the antenna cable.

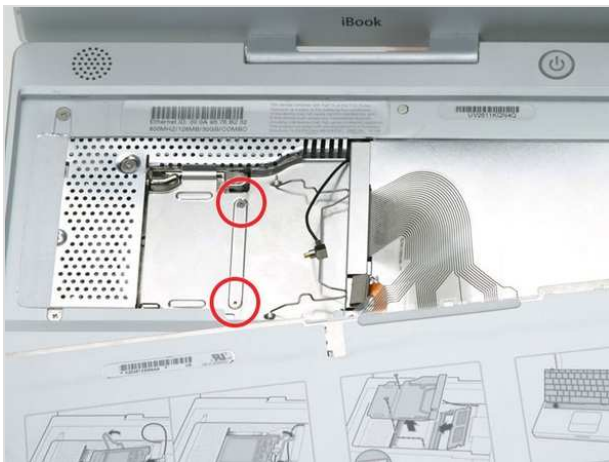

Step 6

- Remove the two 2.5 mm Phillips screws that secure the RAM shield.

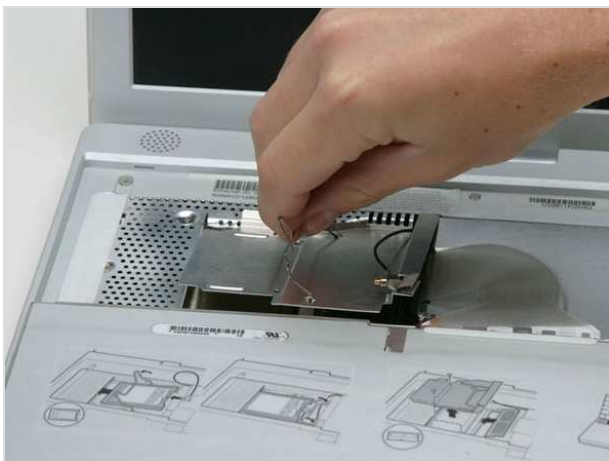

Step 7

- Grasp the metal bracket on top of the RAM shield and pull upward to remove the shield.

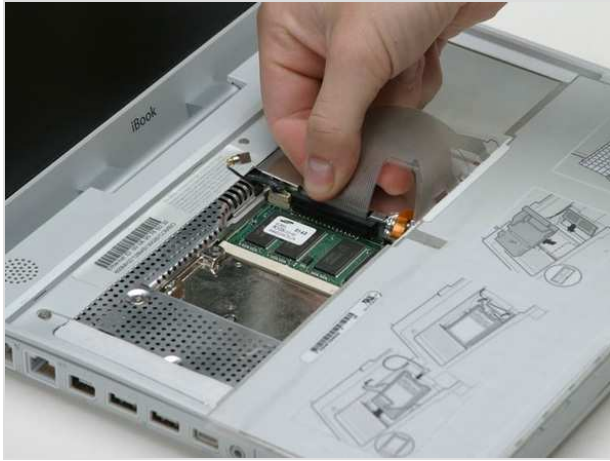

Step 8

- Pull the keyboard cable up from the logic board, holding the cable as close to the connector as possible.



Step 9 — Lower Case

- Your laptop should look approximately like this.



Step 10

- Use a pin (or anything you like) to remove the three rubber feet from the lower case.



Step 11

- Remove the three 5.2 mm newly-revealed Phillips screws.



Step 12

- Use a spudger or small flathead screwdriver to pry up the three metal rings that housed the rubber bumpers.



Step 13

- Remove the one 10 mm and two 20 mm hex screws using a 2mm hex. Alternatively, a T8 Torx screwdriver key will do.



Step 14

- Remove the two 4.2 mm Phillips screws on either side of the battery contacts.



Step 15

- Breathe deeply. Trying times are ahead, but we promise the lower case does come off.
- Push the thin rims of the lower case surrounding the battery compartment in, bending them past the tabs, and then lift up to free that corner of the lower case.



Step 16

- There is a slot on the wall of the battery compartment that locks the lower case in place. Use a small flathead screwdriver to pry out the slot's lower rim and pull up on the lower case to free the slot from the tabs holding it.

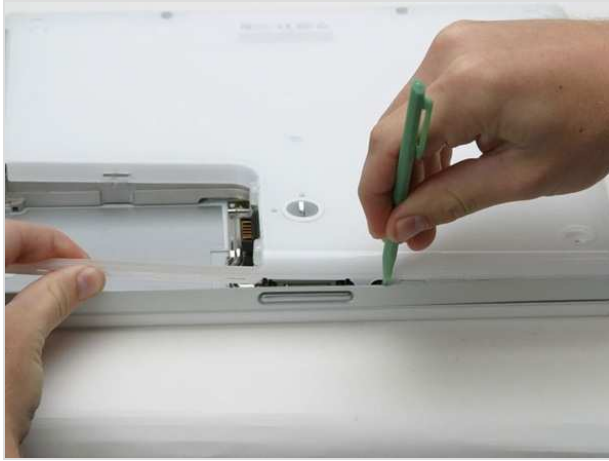

Step 17

- Run a spudger along the seam between the lower case and upper case on the front of the computer to free the tabs locking the lower case. Pull up on the lower case and continue to use the spudger as necessary until you hear three distinct clicks.



Step 18

- Continue to run the spudger around the front, right corner. There are two tabs on the port side of the computer, one near the front corner and one near the sound out port.



Step 19

- Once the front and sides of the lower case are free, turn the computer so that the back is facing you and pull the lower case up and toward you until the back tabs pop free (it may be helpful to jiggle the case up and down).



Step 20

- Remove the small greasy springs with white plastic caps from either side of the battery contacts.

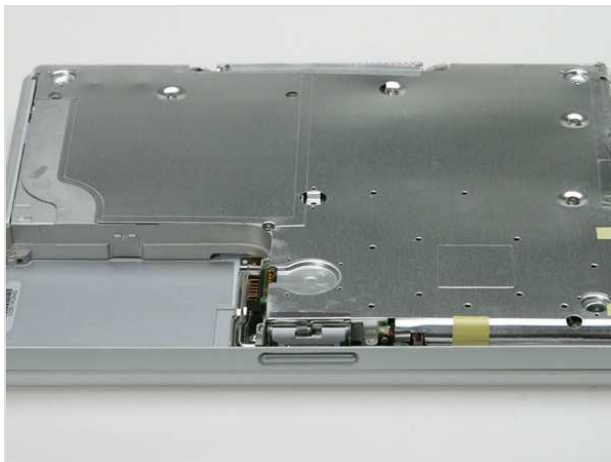

Step 21 — Bottom Shield

- Your laptop should look approximately like this.

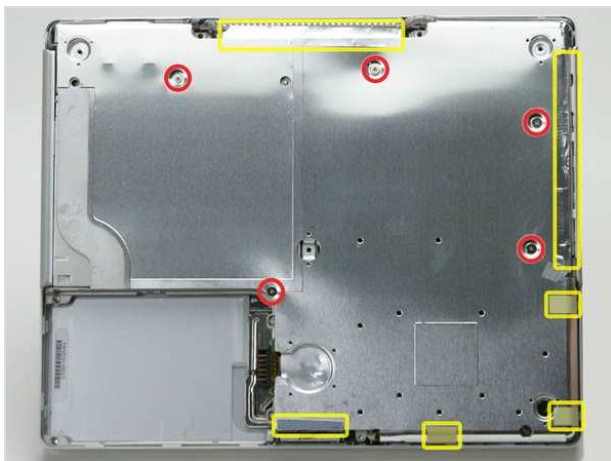

Step 22

- Remove the five 5.8 mm Phillips screws from the bottom shield.
- Peel back the yellow tape and foil shielding outlined in the image.

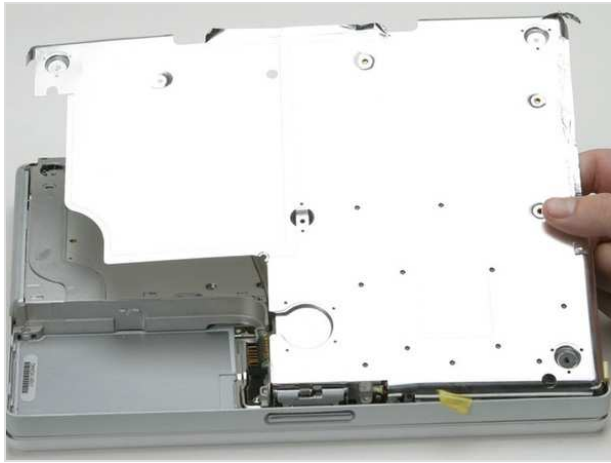

Step 23

- Lift the bottom shield off.

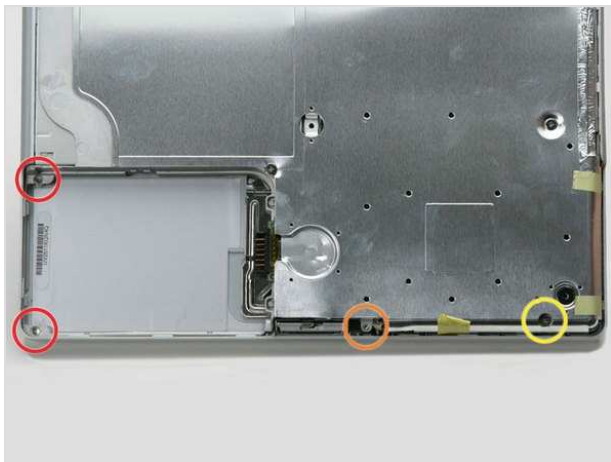

Step 24 — Upper Case

- Remove the following 4 screws on the bottom of the computer:
 - Two 3 mm Phillips from the left side of the computer.
 - One 4.5 mm Phillips near the latch mechanism (this screw may be missing in 800 MHz iBooks)
 - One 14.2 mm Phillips near the front, right corner.



Step 25

- Use a straightened paperclip to open the optical drive tray.

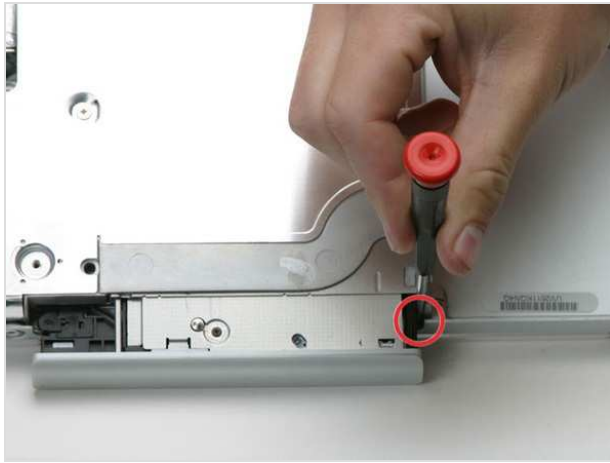

Step 26

- Pull the optical drive out just enough so that you can access and remove a Phillips screw near the battery compartment.



Step 27

- Pull the optical drive a bit more so that you can access and remove a second Phillips screw near the power receptacle.



Step 28

- Turn over the computer and open it.
- Pry up the magnet covering a Phillips screw near the middle of the computer.

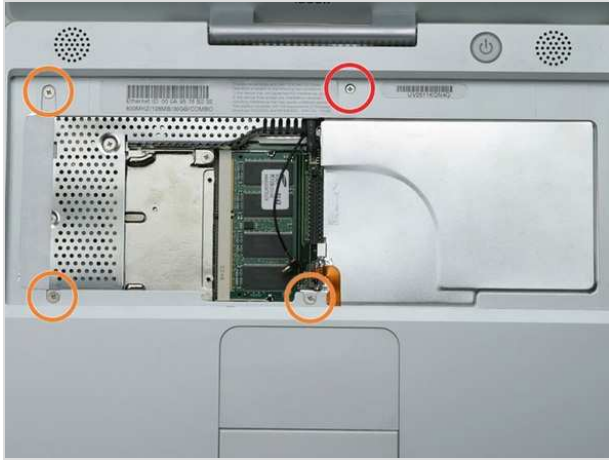

Step 29

- Remove the following 4 screws on the edges of the keyboard area.
 - One 4.5 mm Phillips underneath where the magnet was.
 - Three 6 mm Phillips in plastic depressions.



Step 30

- Peel up the foil tape covering the speaker cable near the ports.

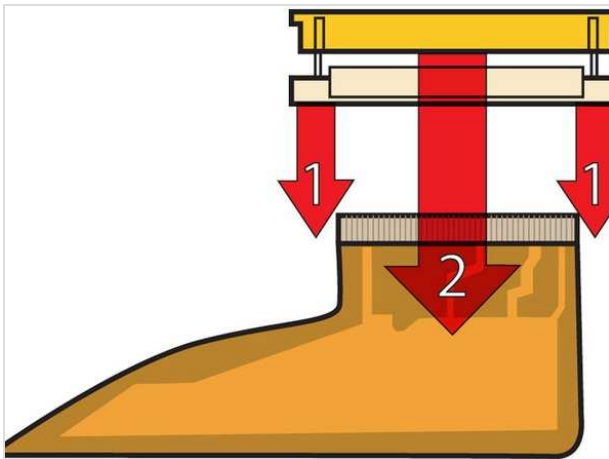

Step 31

- This is a diagram of the trackpad ribbon clamp connector you will disconnect in the next step.
- 1) With your fingernails, grasp the locking bar on either side and pull up a small amount (about 1/16" or 2 mm).
- 2) After disengaging the locking bar, slide the cable out of the connector.







Step 32

- Loosen the trackpad connector by pulling the top piece up slightly, freeing the trackpad ribbon.
- Slide the orange trackpad ribbon out of the connector.



Step 33

- Before you can yank the upper case off with joy, you must disconnect both the blue and white power cable and red and black speaker cable as described in the next steps. 
- Lift the upper case from the left side and use your other hand to pull out the right side in order to clear the power receptacle.
- There may be a thin metal bar fastened to the upper case by the two screws on either side of the optical drive. This bar provides rigidity around the optical drive; don't forget it when reassembling. 



Step 34

- The connectors at the ends of the cables are attached very firmly to the sockets on the logic board. Pulling directly on the cable will either separate the cable from its connector or the socket from the logic board. 
- Lift the upper case enough to disconnect the blue and white power cable from the logic board. Using your fingernails or a dental pick, carefully pry the connector from its socket. Make sure you're pulling only on the connector and not on the socket.

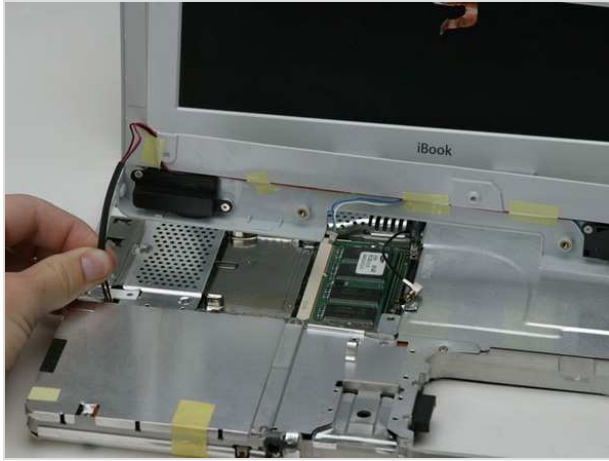

Step 35

- Lift the upper case off completely and disconnect the red and black speaker cable from the logic board. As before, make sure you're pulling only on the connector and not on the socket.

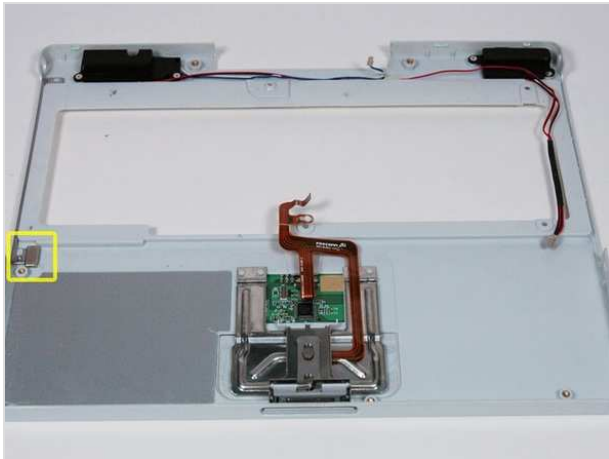

Step 36

- There is a magnet that allows the computer to detect when the laptop is closed. If this magnet is not present your computer will not automatically go to sleep. Be sure the magnet is in the position indicated.

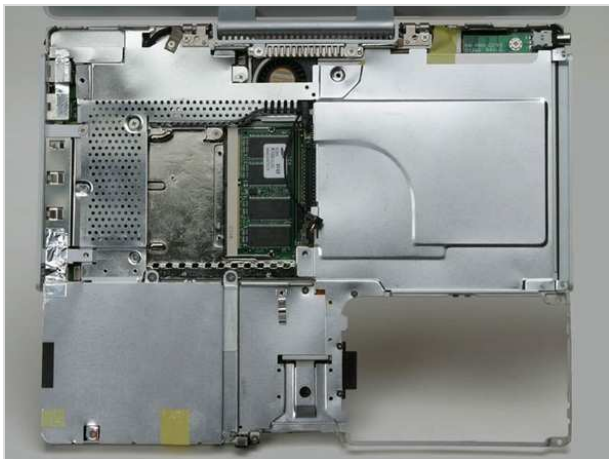

Step 37 — Top Shield

- Your laptop should look approximately like this.

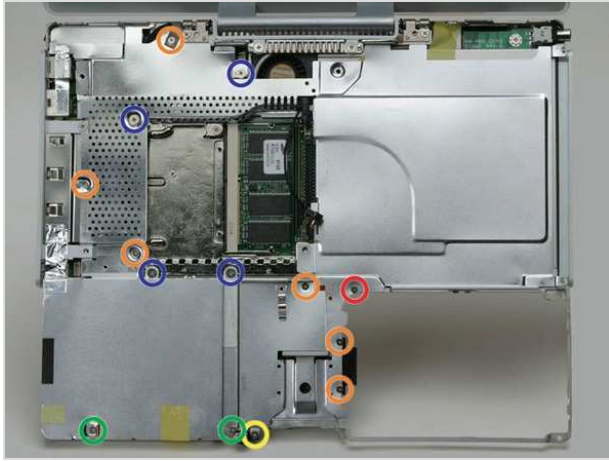

Step 38

- Remove the following 14 screws (some models may be missing a couple of screws):
 - One 2.5 mm Phillips.
 - Six 3.5 mm Phillips.
 - One 4.5 mm Phillips near the sleep light with a small shaft.
 - Two 4.5 mm Phillips with larger shafts.
 - Four 5 mm Phillips
 - If a screw is inserted in the left hole, the 14.2 mm screw in step 24 can not be inserted to hold the top case down.

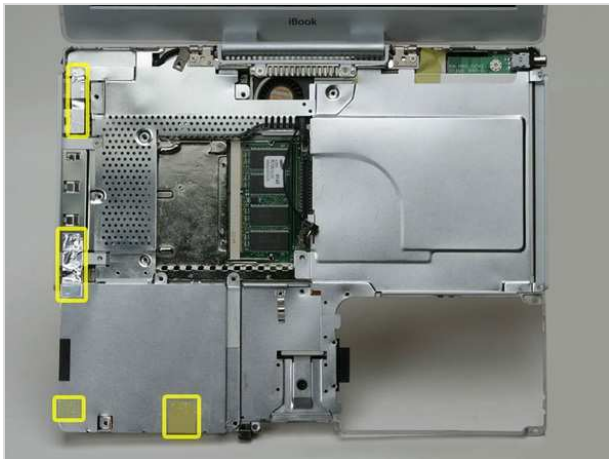

Step 39

- Peel back three strips of yellow tape in the bottom left corner.
- Peel back one strip of foil tape in the upper left corner and another near where the trackpad connects to the logic board.

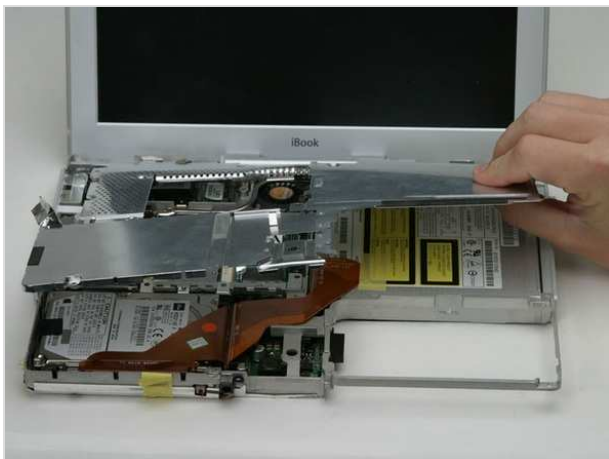

Step 40

- Lift the top shield up from the right side, minding the upper left corner, which may catch on the metal framework.



Step 41 — Optical Drive

- If you have already removed the hard drive or display in a previous step, your iBook may differ slightly from the picture. 
- On the bottom of the computer, disconnect the DC-In cable from the logic board.



Step 42

- Flip the computer over and open the display.
- Open the optical drive using a straightened paperclip (if it's not already opened).
- Peel up the yellow tape from the optical drive.



Step 43

- This step may vary on some iBook models. If the screws shown are not on your iBook, you may need to flip the computer over and remove two screws attaching the bottom of the optical drive to the metal framework. 
- Remove the two Phillips screws securing the optical drive to the metal framework.



Step 44

- Peel back the orange ribbon cable to reveal a single Phillips screw. Remove this screw to free the optical drive from the metal framework.



Step 45

- Lift the optical drive by the edge closest to the screen, minding that the metal bracket at the top left corner doesn't catch on the Airport or inverter cables.



Step 46

- Remove the two 2.5 mm Phillips screws securing the large orange ribbon cable and thin metal bracket to the drive.



Step 47



- Disconnect the ribbon cable from the optical drive.
- If you have a CD or any other object jammed in your optical drive, we have an [optical drive repair guide](#).





To reassemble your device, follow these instructions in reverse order.

This document was last generated on Feb 23, 2012.





Keyboard
2 Phillips Screws



Lower Case (under feet)
3 Phillips



Lower Case
2 Torx

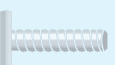

Lower Case
1 Torx

Lower Case (battery compartment)
2 Phillips

Upper Case bottom (red)
2 Phillips



Upper Case bottom (orange)
1 Phillips





To organize your screws, simply place each screw in the appropriate box as you remove them from your laptop.

If you are not planning on immediately reassembling your laptop, you may want to tape the screws to this paper.



Due to model variations, the screws you remove may differ slightly from this guide.



Upper Case bottom (yellow)
1 Phillips



Upper Case (optical drive)
2 Phillips

Upper Case top (red)
1 Phillips



Upper Case top (orange)
3 Phillips

Bottom Shield
5 Phillips

Fan
2 Phillips



 

IO Bezel (red)
1 Phillips









↓



IO Bezel (orange)
1 Phillips





Top Shield (red)
1 Phillips





Top Shield (orange)
6 Phillips



↓





Top Shield (yellow)
1 Phillips



Top Shield (green)
4 Phillips



Modem
3 Phillips



HD Replacement
4 T8 Torx



↙ ↘



To organize your screws, simply place each screw in the appropriate box as you remove them from your laptop.



If you are not planning on immediately reassembling your laptop, you may want to tape the screws to this paper.

Due to model variations, the screws you remove may differ slightly from this guide.





Display
2 Phillips



↓



Optical Drive
1 Phillips





Optical Drive (cable)
2 Phillips





DC-In Board
1 Phillips



↓



Logic Board (heat sink)
3 Phillips



Logic Board (red)
1 Phillips



Logic Board (orange)
1 Phillips

